

# Pressure control valves type AGIR, AGIS, AGIU

two stage, subplate mounting, ISO 5781 sizes 10, 20 and 32

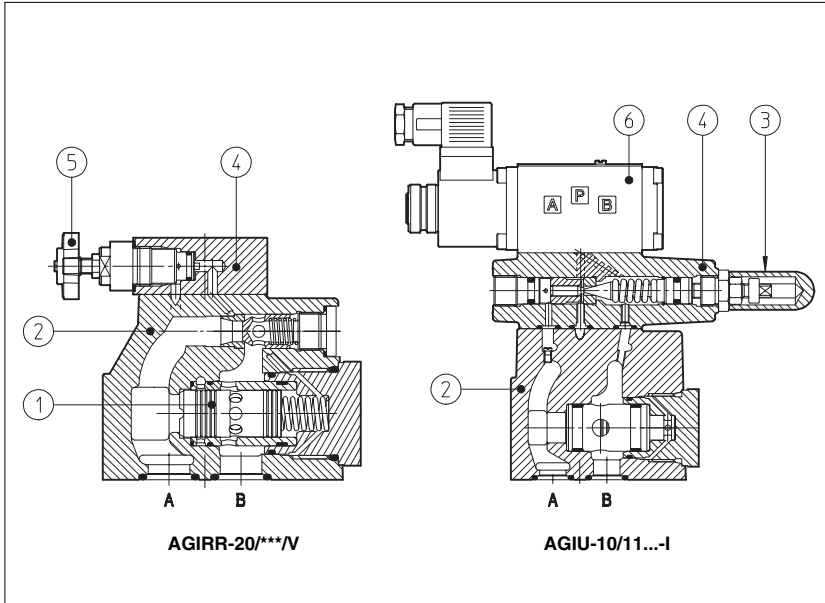

AGIR, AGIS and AGIU are double stage pressure control valves with balanced poppet designed to operate in oil hydraulic systems.

AGIR: pressure reducing;

AGIS: sequence;

AGIU: unloading.

In standard versions the piloting pressure of the poppet ① of the main stage ② is regulated by means of a grub screw protected by cap ③ in the cover ④. Optional versions with setting adjustment by handwheel ⑤ instead of the grub screw are available on request.

Clockwise rotation increases pressure. Unloading valves AGIU can be equipped with a venting solenoid valve ⑥ (for normally open or normally closed valves).

Another setting control can be made through the independent pilot port.

Mounting surface: ISO 5781 sizes 10, 20 and 32.

Max flow:

for AGIR = 160, 300, 400 l/min

for AGIS = 200, 400, 600 l/min

for AGIU = 100, 200, 300 l/min.

Pressure up to 350 bar.

## 1 MODEL CODE

AGIU	*	-	20	/	1	0	/210	/V	-I	X	24DC	**	/*
Pressure control valves subplate mounting <b>AGIR</b> = pressure reducing <b>AGIS</b> = sequence <b>AGIU</b> = unloading					(1)	(1)			(1)	(1)	(1)		Synthetic fluids: <b>WG</b> = water-glycol <b>PE</b> = phosphate ester
Only for AGIR and AGIS: <b>R</b> = with check valve <b>-</b> = without check valve													Design number
Size: <b>10</b> <b>20</b> <b>32</b>													Supply voltage, see section 7: <b>00</b> = solenoid valve without coils (only for OI solenoid)
Number of different setting pressure <b>1</b> = one setting pressure													<b>X</b> = without connector See section 6 for available connectors, to be ordered separately
<b>0</b> = venting with de-energized solenoid <b>1</b> = venting with energized solenoid													Solenoid of pilot valve: <b>-I</b> = solenoid OI (DHI) for AC and DC supply
Pressure range: <b>50</b> = 4÷50 bar (AGIR*); <b>100</b> = 6÷100 bar; <b>210</b> = 7÷210 bar; <b>350</b> = 8÷350 bar													Options (2): <b>/V</b> = regulating handwheel instead of a grub screw protected by cap <b>/VF</b> = regulating knob instead of a grub screw protected by cap (only for AGIS, AGIU) <b>/VS</b> = manual override with safety locking instead of a grub screw protected by cap (only for AGIS, AGIU)
(1) Only for AGIU with solenoid valve for venting (2) For handwheel features, see technical table K150													Only for AGIU: <b>/D</b> = internal drain <b>-</b> = standard unloading characteristics <b>/5, /6</b> and <b>/7</b> = other unloading characteristics, see section 5

## 2 HYDRAULIC CHARACTERISTICS

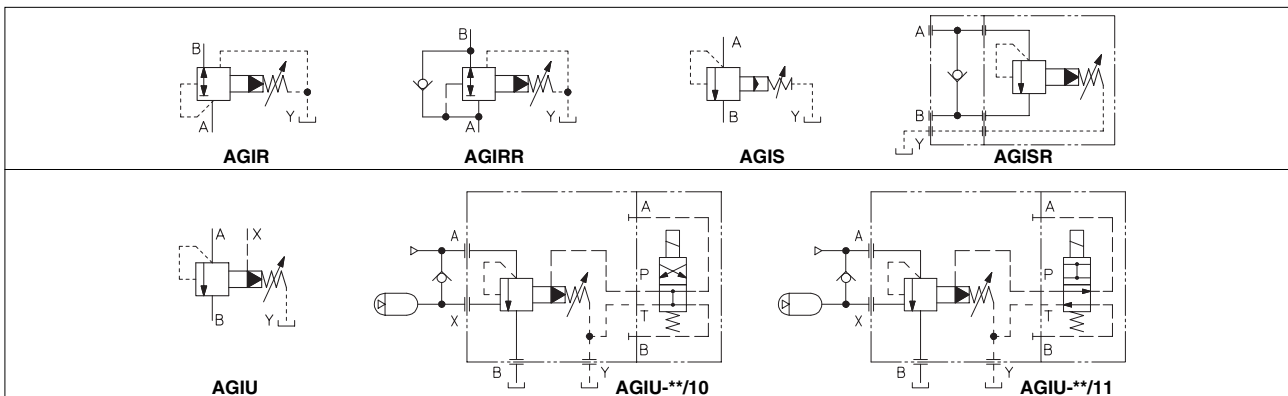

Valve model	AGIR-10	AGIR-20	AGIR-32	AGIS-10	AGIS-20	AGIS-32	AGIU-10	AGIU-20	AGIU-32
Max flow [l/min]	160	300	400	200	400	600	100	200	300
Pressure range [bar]	4÷50 (AGIR*); 6÷100; 7÷210; 8÷350								

### 3 MAIN CHARACTERISTICS OF PRESSURE CONTROL VALVES TYPE AGIR, AGIS, AGIU

Assembly position / location	Any position
Subplate surface finishing	Roughness index $\sqrt{0.4}$ , flatness ratio 0,01/100 (ISO 1101)
Ambient temperature	-20°C to + 70°C
Fluid	Hydraulic oil as per DIN 51524 . . . 535; for other fluids see section 11
Recommended viscosity	15 ÷ 100 mm <sup>2</sup> /s at 40°C (ISO VG 15 ÷ 100)
Fluid contamination class	ISO 19/16, achieved with in line filters at 25 µm value and $\beta_{10} \geq 75$ (recommended)
Fluid temperature	-20°C +60°C (standard and /WG seals) -20°C +80°C (/PE seals)

#### 3.1 Coils characteristics

Insulation class	H
Connector protection degree	IP 65
Relative duty factor	100%
Supply voltage and frequency	See electric feature 7
Supply voltage tolerance	± 10%

### 4 REGULATED PRESSURE VERSUS FLOW DIAGRAMS based on mineral oil ISO VG 46 at 50°C

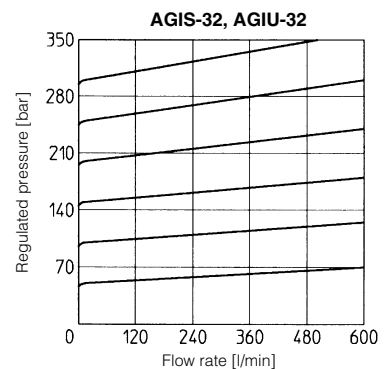
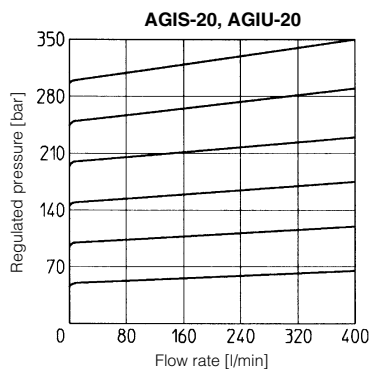
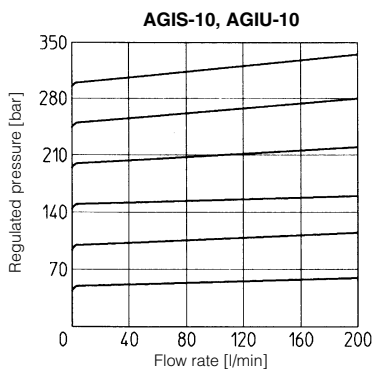
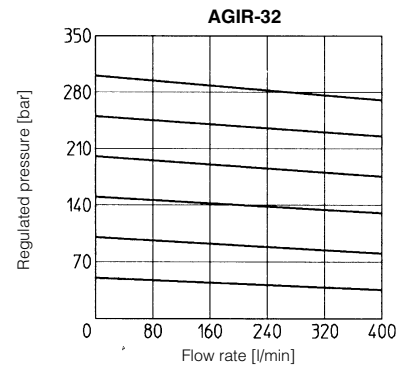
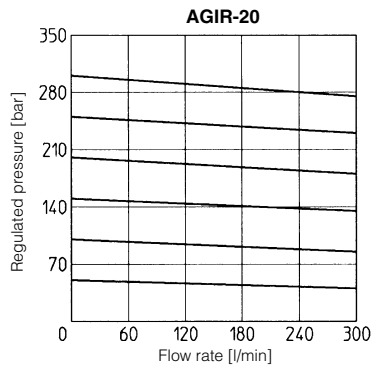
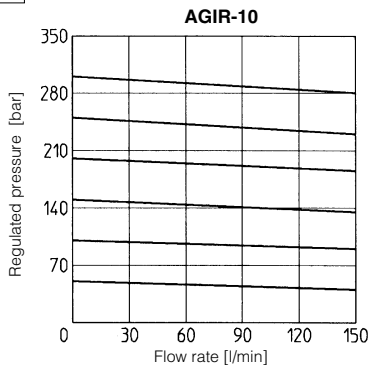

Note: for AGIU-10, the max flow rate is 100 l/min

Note: for AGIU-20, the max flow rate is 200 l/min

Note: for AGIU-32, the max flow rate is 300 l/min

### 5 OPERATING DIAGRAM based on mineral oil ISO VG 46 at 50°C

- 1 = AGIR-10 A → B
- 2 = AGIR-20 A → B
- 3 = AGIR-32 A → B
- 4 = AGIR-10 B → A
- 5 = AGIR-20 B → A
- 6 = AGIR-32 B → A

- 7 = AGIS-10
- 8 = AGIS-20
- 9 = AGIS-32

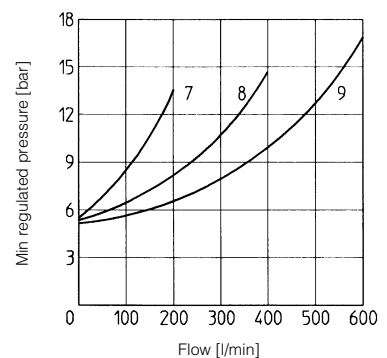
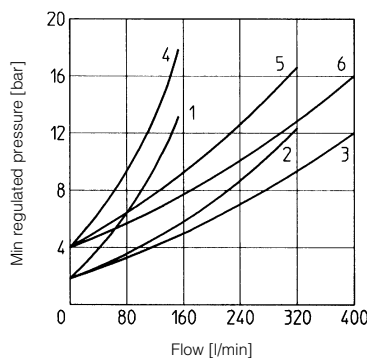

#### Opening/closing diagram for AGIU

- 1 = AGIU-\*/.../standard
- 2 = AGIU-\*/.../5
- 3 = AGIU-\*/.../6
- 4 = AGIU-\*/.../7

#### NOTES

- 1) Short pipes with low resistance must be used between the unloading valve and the accumulator;
- 2) When the resistance is high, the hydraulic pilot signal must be taken as closed as possible to the accumulator;
- 3) With high pump flow and small valve differential pressure of intervention it is unadvisable to use the version with external drain;
- 4) When to use the BA-\*25 subplates:
  - a) in applications with working frequencies >10 Hz use subplates type BA-\*25/4 (spring with 4 bar of cracking pressure);
  - b) in applications with working frequencies <10 Hz use subplates type BA-\*25/2 (spring with 2 bar of cracking pressure);

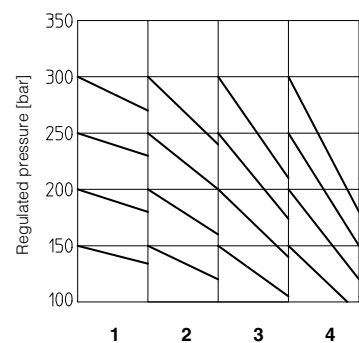
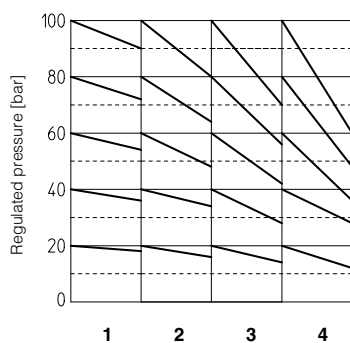

**6 ELECTRIC CONNECTORS ACCORDING TO DIN 43650 FOR AGIU WITH SOLENOID VALVE**

The connectors must be ordered separately

Code of connector	Function
<b>SP-666</b>	Connector IP-65, suitable for direct connection to electric supply source
<b>SP-667</b>	As SP-666 connector IP-65 but with built-in signal led, suitable for direct connection to electric supply source

For other available connectors, see tab. E010 and K500.

**7 ELECTRIC FEATURES FOR AGIU WITH SOLENOID VALVE**

Type of solenoid	External supply nominal voltage $\pm 10\%$ (1)		Type of connector	Power consumption (3)	Code of spare coil	Colour of coil label
OI	DIRECT CURRENT	6 DC 12 DC 24 DC 48 DC	SP-666 or SP-667	33 W	SP-COU-6DC /80 SP-COU-12DC /80 SP-COU-24DC /80 SP-COU-48DC /80	brown green red silver
	ALTERNATE CURRENT	110/50 AC (2) 120/60 AC 230/50 AC (2) 230/60 AC	SP-666 or SP-667	60 VA (4)	SP-COI-110/50/60AC /80 SP-COI-120/60AC /80 SP-COI-230/50/60AC /80 SP-COI-230/60AC /80	yellow white light blue silver

- (1) For other supply voltages available on request see technical table E010.
- (2) Coil can be supplied also with 60 Hz of voltage frequency: in this case the performances are reduced by 10 ÷ 15% and the power consumption is 55 VA.
- (3) Average values based on tests performed at nominal hydraulic condition and ambient/coil temperature of 20°C.
- (4) When solenoid is energized, the inrush current is approx 3 times the holding current. Inrush current values correspond to a power consumption of about 150 VA.

**8 DIMENSIONS [mm]**

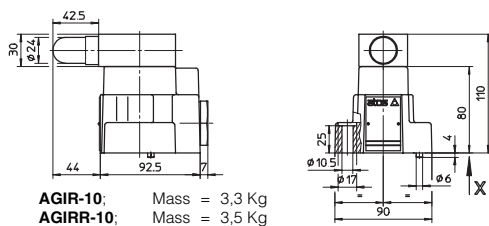

**AGIR-10;** Mass = 3,3 Kg  
**AGIRR-10;** Mass = 3,5 Kg

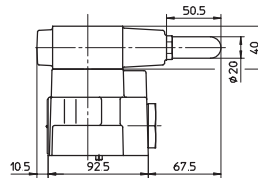

**AGIS-10;** Mass = 3,8 Kg  
**AGISR-10;** Mass = 4 Kg  
**AGIU-10;** Mass = 3,8 Kg

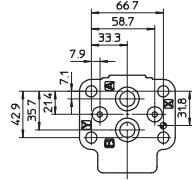

**Mounting surface**  
**ISO 5781-AG-06-2-A size 10:**  
 Fastening bolts: 4 socket head screws M10x45  
 Seals: 2 OR 109/70, 2 OR 3068  
 Ports A, B: Ø = 14 mm  
 Ports X, Y: Ø = 5 mm

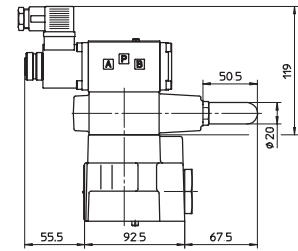

**AGIU-10/10\*\*-IX;** Mass = 5,3 Kg

The drawing shows AGIU with solenoid valve type DHI

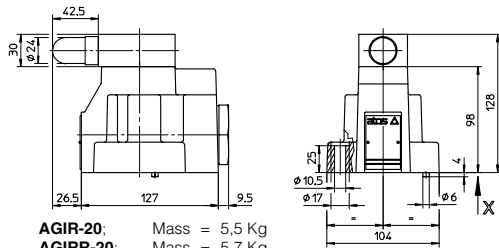

**AGIR-20;** Mass = 5,5 Kg  
**AGIRR-20;** Mass = 5,7 Kg

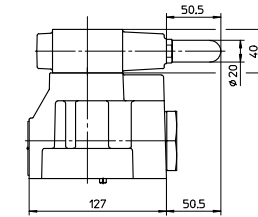

**AGIS-20;** Mass = 6 Kg  
**AGISR-20;** Mass = 6,2 Kg  
**AGIU-20;** Mass = 6 Kg

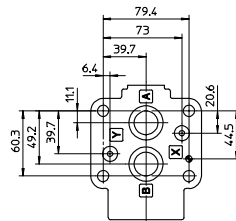

**Mounting surface**  
**ISO 5781-AH-08-2-A size 20:**  
 Fastening bolts: 4 socket head screws M10x45  
 Seals: 2 OR 109/70, 2 OR 4100  
 Ports A, B: Ø = 22 mm  
 Ports X, Y: Ø = 5 mm

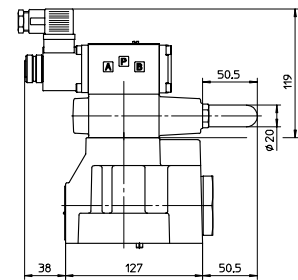

**AGIU-20/10\*\*-IX;** Mass = 7,5 Kg

The drawing shows AGIU with solenoid valve type DHI

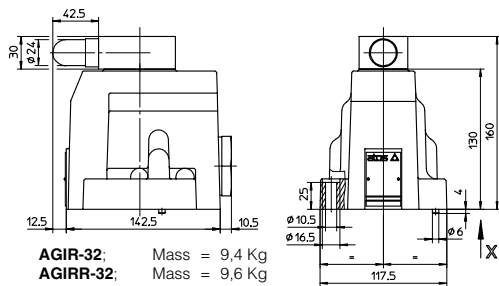

**AGIR-32;** Mass = 9,4 Kg  
**AGIRR-32;** Mass = 9,6 Kg

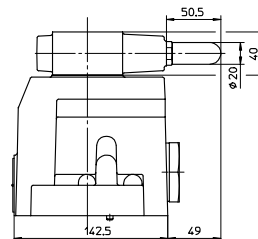

**AGIS-32;** Mass = 9,9 Kg  
**AGISR-32;** Mass = 10,1 Kg  
**AGIU-32;** Mass = 9,9 Kg

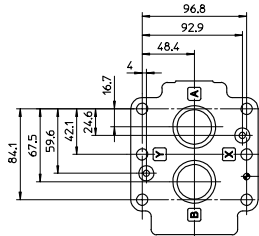

**Mounting surface**  
**ISO 5781-AJ-10-2-A size 32:**  
 Fastening bolts: 6 socket head screws M10x45  
 Seals: 2 OR 109/70, 2 OR 4131  
 Ports A, B: Ø = 28 mm  
 Ports X, Y: Ø = 5 mm

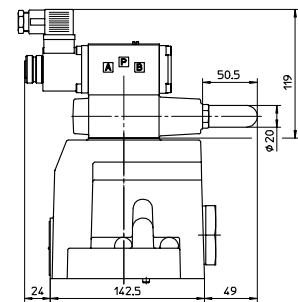

**AGIU-32/10\*\*-IX;** Mass = 11,4 Kg

The drawing shows AGIU with solenoid valve type DHI

Overall dimensions refer to valves with connectors type SP-666

**9 MOUNTING SUBPLATES**

Valves	Subplate model	Port location	Ports				Ø Counterbore [mm]				Mass [Kg]
			A	B	X-Y	OUT	A	B	X-Y	OUT	
<b>AGI*-10</b>	BA-305	Ports A, B, Y underneath;	G 1/2"	G 1/2"	G 1/4"	-	30	30	21,5	-	1
<b>AGI*-20</b>	BA-505		G 1"	G 1"	G 1/4"	-	46	46	21,5	-	2
<b>AGI*-32</b>	BA-705		G 1 1/2"	G 1 1/2"	G 1/4"	-	63,5	63,5	21,5	-	7,5
<b>AGIU-10</b>	BA-325 (with incorporated check valve)	Ports A, B, Y underneath;	G 1/2"	G 3/4"	G 1/4"	G 1/2"	30	36,5	21,5	30	5
<b>AGIU-20</b>	BA-425 (with incorporated check valve)		G 1"	G 1"	G 1/4"	G 1"	46	46	21,5	46	6,5
<b>AGIU-32</b>	BA-625 (with incorporated check valve)		G 1 1/2"	G 1 1/2"	G 1/4"	G 1 1/2"	63,5	63,5	21,5	63,5	13

The subplates are supplied with fastening bolts. For further details see table K280